

Tech Tips



TT 44-11-05

Date: September 23, 2011

2012 Passat, Jetta, Beetle – Steering Wheel Off Center

March 23, 2012: Update to Include Additional Models

When checking for steering wheel alignment on any new vehicle listed, be aware that the position of the steering wheel can vary up to 2.5 degrees total. This is dependent on the position of the height adjustment of the steering wheel itself. In the full up position, the steering wheel is set approx. 1.25 degrees off center to the right and accordingly, 1.25 degrees to the left in the all down position. By controlling the offset, when the wheel is pulled into the normal driving position (center tilt) it will be centered. When testing for steering wheel center, make sure the adjustment is centered on the tilt.

Technical Service Bulletin

44-13-04 - Four Wheel Alignment Overview

Release date: Jul 11, 2013

Transaction No.: 2031087/7

Condition

Model(s)	Year	Eng. Code	Trans. Code	VIN Range From	VIN Range To
Passat, Jetta, Beetle Sedan	2012-2013	All	All	All	All
Jetta Hybrid, Beetle Convertible	2013	All	All	All	All

44 13 04 June 27, 2013 2031087 Supersedes T.B. V441303 dated May 16, 2013 to modify subtitles to avoid warranty confusion.

Four Wheel Alignment Overview, Steering Wheel off Center, Vehicle Drift/Pull

This Technical Bulletin provides an overview for performing vehicle four wheel Alignment, and information on improving vehicle drift/pull using selective tire placement. The information provided is based on the Hunter alignment equipment, Hunter GSP9700 with StraightTrak (VAS 6230x) and John Bean RF2000 with Optiline (VAS 631 1A) diagnostic balancer. The alignment information provided in this bulletin is not limited to the Hunter alignment equipment, and still applies with the use of other Volkswagen approved alignment equipment. The diagnostic procedure for selective tire placement, to improve vehicle drift/pull, will require the use of one of the diagnostic balancers previously mentioned.

This Technical Service Bulletin is divided into four (4) Sections:

Section 1: Alignment overview & Steering Wheel Off Center (SWOC).

Section 2: Drift/pull concerns at Pre-Delivery Inspection (PDI).

Section 3: Customer concerns for vehicle drift/pull

Section 4: Volkswagen approved diagnostic balancers to address vehicle drift/pull

The following topics are addressed in this bulletin:

1. Alignment Technologies
2. Toe adjustment –Steering Wheel Off Center (SWOC)
3. Camber adjustment
4. Caster measurement
5. Selective tire placement to improve vehicle drift/pull.

Technical Background

The information provided in this bulletin is intended to assist technicians in obtaining the correct alignment results, and maximize the use of the alignment, and tire balancer equipment. Vehicle alignment should always be performed based on the information published in the service manual.

Section 1: Alignment Technologies

 Note:

The repair procedures outlined in this bulletin, to address vehicle drift/pull or Steering Wheel Off Center, will be covered **ONLY ONCE** under warranty, within the first 6 Months/6000 miles of the warranty in service date.

 Note:

Email a scanned copy of the before and after alignment measurements to VWGoA.Chassis@vw.com, and file the printed copy with the Repair Order. If a Volkswagen Technical Assistance (VTA) ticket was opened, the alignment before and after measurements should be attached, before the VTA is closed. This is required for all alignment check or repairs performed under warranty.

Email must include the following information:

- VIN
- Repair Order (RO) Number
- Mileage (from RO)
- Dealer Code

The alignment data must be a legible scanned copy of the original print or screen capture (picture). The recommended formats are PDF or JPEG. Below are examples of acceptable attachments:

Customer

Vehicle Ident no.

Technician

Date

Repair order no.

License plate no.

First reg. date

Model

Volkswagen : Passat : 2012 : Standard Suspension (G02) (G11)

Odometer reading: km/miles 8

Complaints or reason for alignment check

	Before	Target Data	After
Rear axle	Camber		
	left	-1.28	-1.14
	right	-0.48	-1.15
	cross	-0.38	-0.95
Setback			
left	0.00	0.00	-0.07
right	-0.06	+/-0.05	0.01
total	0.00	+/-0.10	0.08
Geometrical driving axis			
Axis Offset			
left	-0.54	+0.30	-0.42
right	-0.17	+0.30	-0.29
cross	-0.38	+0.30	-0.17
left	7.21	+0.30	0.17
right	7.15	+0.30	7.45
cross	0.08	+0.30	0.08
Front axle	SAI		
	left	13.08	12.56
	right	11.32	11.41
	cross	1.36	0.00
Track differential angle			
left	-1.38	+0.20	-1.38
right	-1.20	+0.20	-1.20
left	-0.05	+0.05	0.04
right	0.10	+0.05	0.04
total	0.05	+0.10	0.08
Setback			
left steer	-38.48	0.00	0.08
right steer	31.54	0.00	-38.48
Max steering lock			
left	31.54	0.00	31.54
right steer	32.34	0.00	32.34
Wheelbase Difference			
left	32.34	0.00	32.34
right	-39.12	0.00	-39.12
Track Width Difference			
left		0.00	-0.50
right		0.00	-0.30
Lateral Offset			
left		0.00	-0.20
right		0.00	-0.20

* This value is not within specification. The wear, handling and safety problems may result.

Work Order:
 Last Name:
 Company:
 VIN:
 License:
 Year:
 Technician:
 Mileage:
 Date:

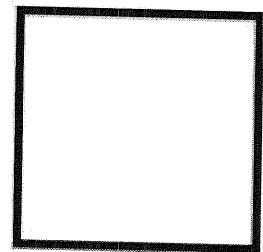

Volkswagen : Passat : 2012 : Standard Suspension (G02 G11)

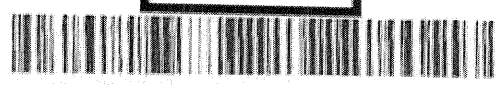
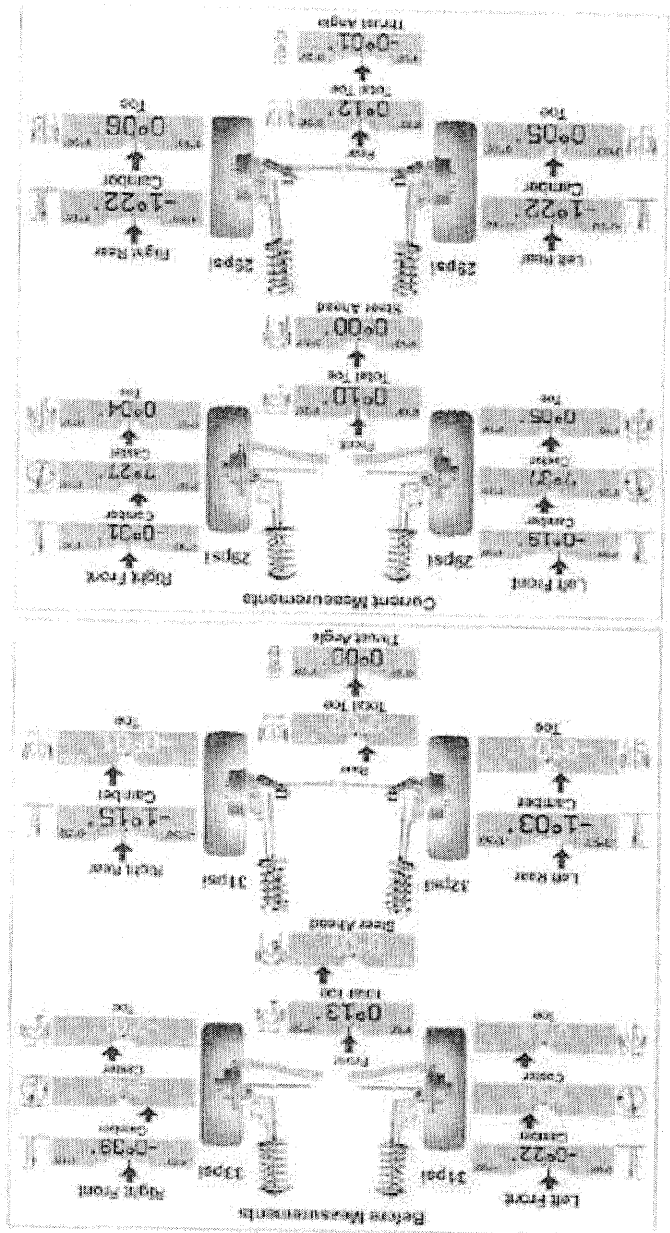

Not applicable.

Service

Section 1. Alignment terminology

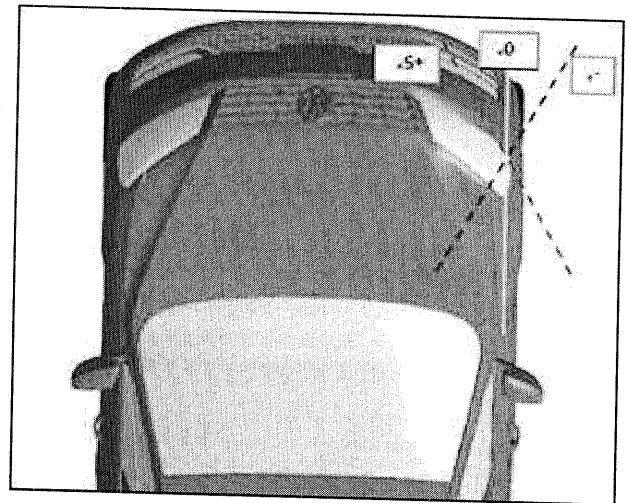

TOE - The amount the tires point inwards or outwards when viewing the car from above.

Figure 1

Positive toe (red line) or Toe-in: The tires point inwards towards the center of the vehicle.

Negative toe (blue line) or Toe-out: The tires point outwards away from the center of the vehicle

Figure 1

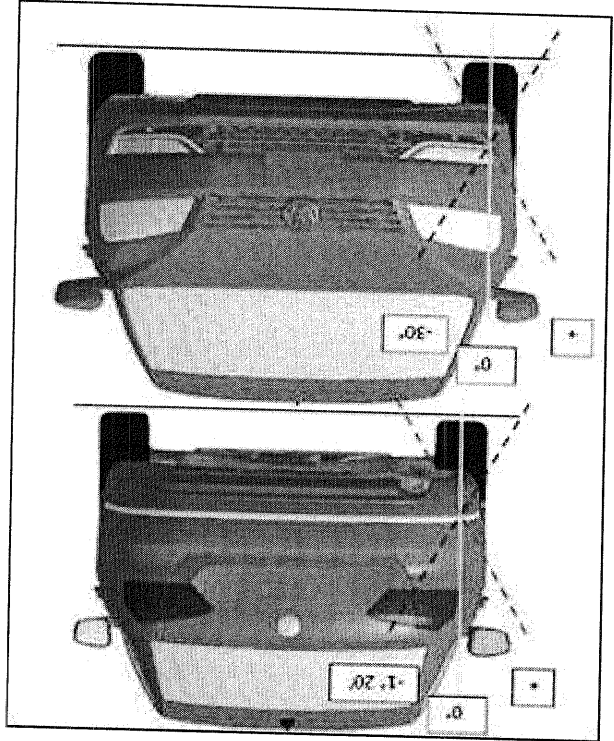

CAMBER - Angle between the vertical axis of the wheel and the vertical axis of the vehicle when viewed from the front or rear.

Positive (red line): The upper sidewall of the tire is tilted outwards away from the center of the vehicle.

Negative (blue line): The upper sidewall of the tire is tilted towards the center of the vehicle.

Figure 2

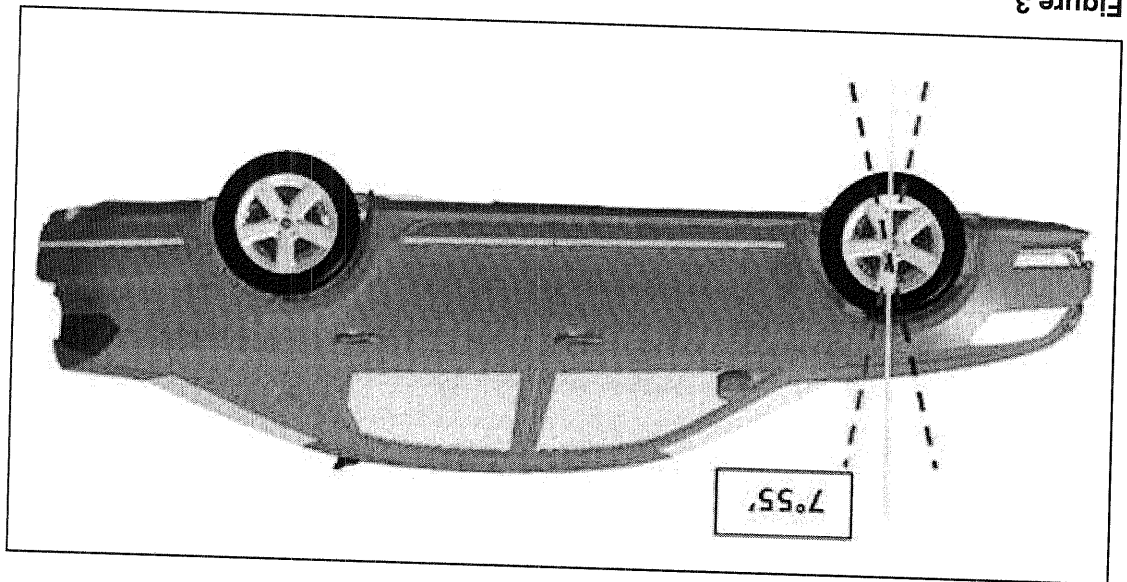

Figure 3

CASTER - When viewing a car from the side, the angle of the vehicle's steering axis is defined by drawing a line through the upper and lower ball joints (for a double wishbone front suspension), or through the strut tower mount and the lower ball joint.

Positive (red line): The line leans towards the rear of the car.

Negative (blue line): The line leans towards the front of the car.

Tip:

For additional information on wheel alignment see Self Study Program (SSP) 860103 – Wheel Alignment – Basics.

2. Toe adjustment – Steering Wheel Off Center (SWOC)

Front and rear toe adjustment procedures are located in the repair manual under, Repair Manual > Chassis > Suspension, Wheel, Steering > 44 Wheels, Tires, Wheel Alignment > General Information.

When performing wheel alignment, the steering column must be adjusted to the center tilt position. This is due to steering wheel off set of up to 1.2 degrees from center tilt position of the steering column to the full up or the full down tilt position. See illustration 4 & 5 below.

Tip:

The tools shown in figure 4 & 5 were used to demonstrate the steering wheel off set. These are not dealer required tools.

Steering wheel in the fully up tilt position and off set to the right.



Figure 4

Steering wheel in the fully down tilt position and off set to the left.

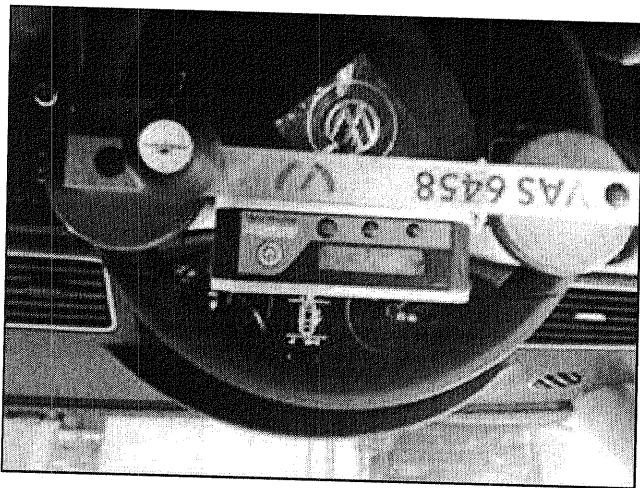

Figure 5

Tip:

For a video demonstration of steering wheel off set, go to: VWwebservice > Select your view: After sales > Quick Tips > Quick Tips for Technicians > Chassis.

Note:

DO NOT remove the steering wheel from the steering column to correct steering wheel off center. If it has been determined that the steering wheel is off center with the steering in the center tilt position, an alignment should be performed and the toe adjusted to correct the steering position.

3. Camber adjustment

Camber adjustments should be made based on the information in the repair manual.

Note:

If the sub-frame bolts are loosened / removed to adjust camber, the bolts **MUST** be replaced with new bolts. Sub-frame bolts are torqued to yield and should never be re-used after they are loosened.

- Caster is not an adjustable angle for the models addressed in this bulletin.
1. When performing alignment using the Hunter equipment, after the initial "Before" measurements are displayed, additional steps are required to read the correct caster measurement. Without these additional steps, the equipment may display caster measurements that are out of specification. Please follow the steps below to obtain the correct caster measurements.

4. Caster Measurement

When the initial "Before" measurements are displayed, scroll down to make additional measurements.

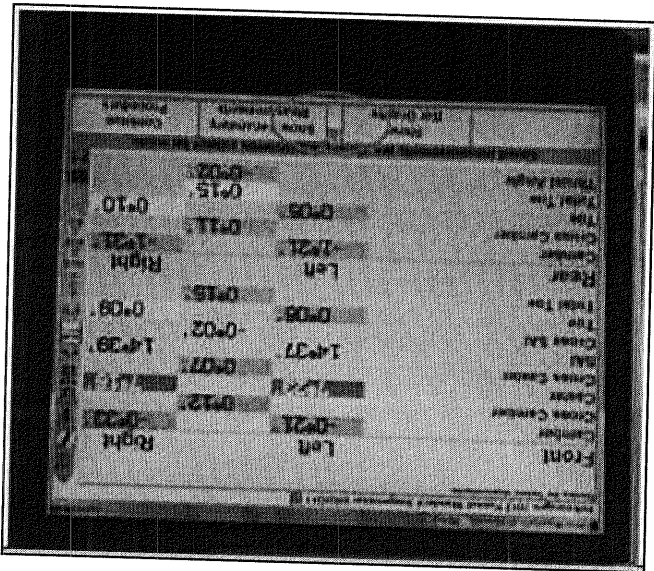

Figure 6

Press K3 to select > Make Additional Measurement.

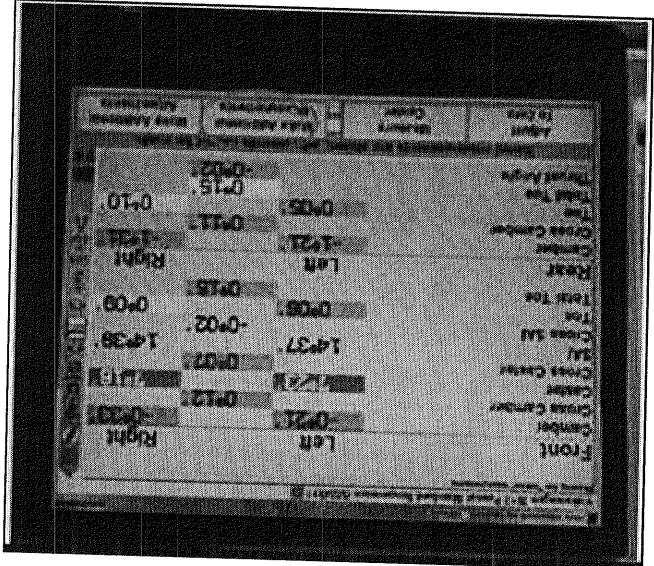

Figure 7

Scroll down to select > Frame Angle > Press K4 to select OK.

Tip:

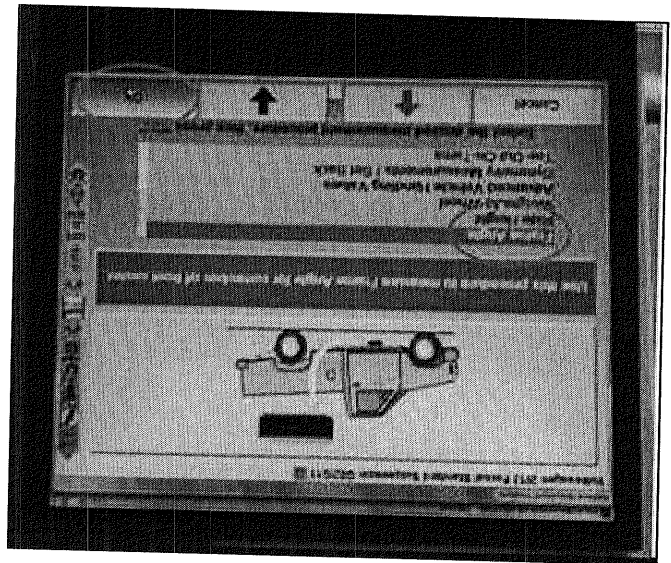

Figure 8

A digital level (Accelerometer) can be used to measure vehicle frame angle. If a tool is not available, measure the vehicle ride height (Standing height) and if within specification per the repair manual, enter 0.4° for the left and right frame angle.

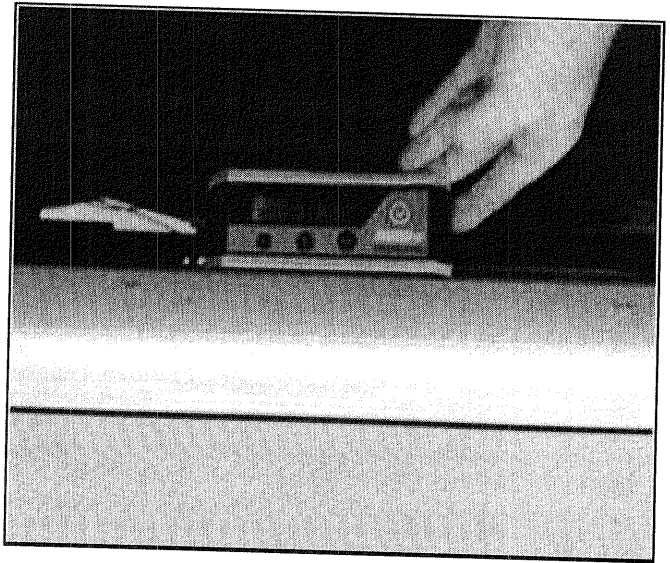

Figure 9

Measure the vehicle frame angle at the door sills using a digital level (accelerometer).

Tip:

The frame angle for the car in figure 9 measures 0.9°, where the rear is higher than the front. The nominal frame angle is 0.4° by design and must be subtracted from the measured frame angles.
For example $0.9^\circ - 0.4^\circ = 0.5^\circ$

Enter the angles in the left and right frame angle fields > press K4 to select OK.
The caster measurement will now read correct. Please note that cross caster measurement will remain the same.

Figure 10

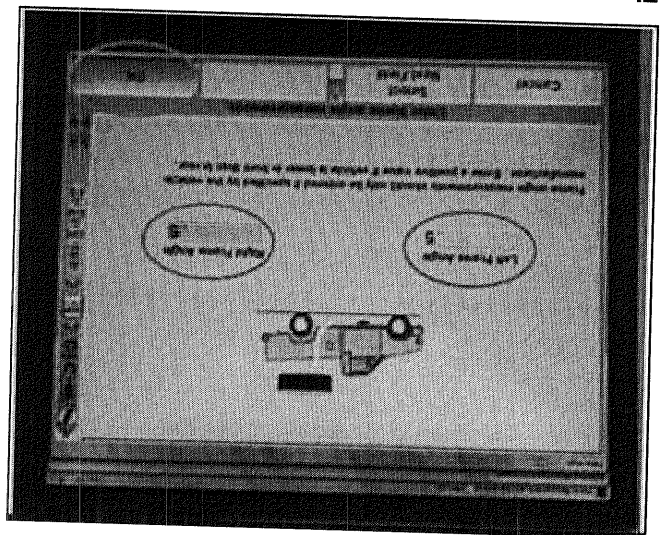

Vehicle ride height and symmetry measurement/Set back are very important when diagnosing vehicle suspension or drifting/pulling concerns. To include these measurement in the alignment summary select K3 > Make Additional Measurement and scroll down to select these measurements.

Axle symmetry measurements/set back are displayed in angles. For easier understanding it is best to have the measurements displayed in distances. Follow the procedures below to measure axle symmetry and display the measurements in distances.

After selecting "Make Additional Measurements", scroll down and select > Symmetry Measurements/ Set Back > Press K4 for OK.

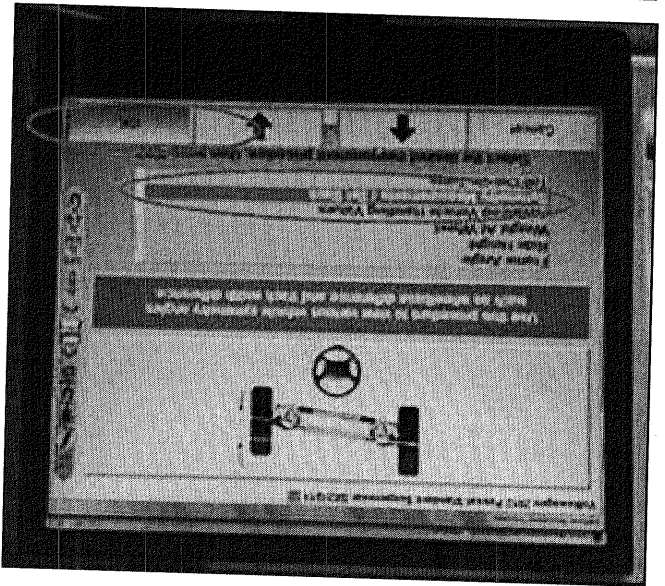

Figure 11

Center the front wheels as shown on the monitor. > Press K4 for Ready.

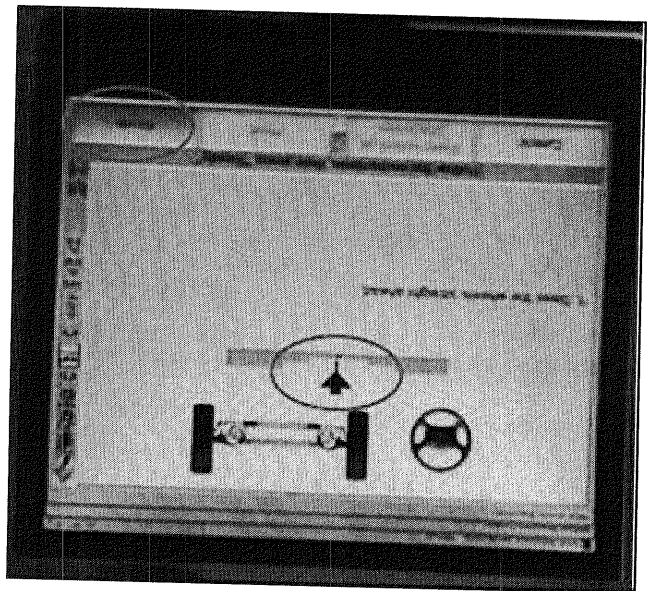

Figure 12

The axle symmetry/ set back will be displayed in angles. To show angles as Distances > Press K2.

Enter the Rim Width

16" = 6.5"

17" = 7"

18" = 8"

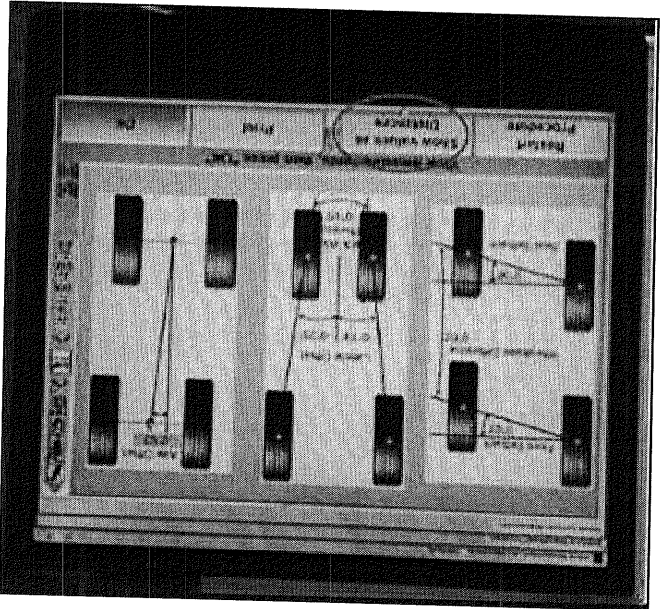

Figure 13

Ensure that the correct box is checked depending on the type of wheel clamp spade that is used > Press K4 for OK.

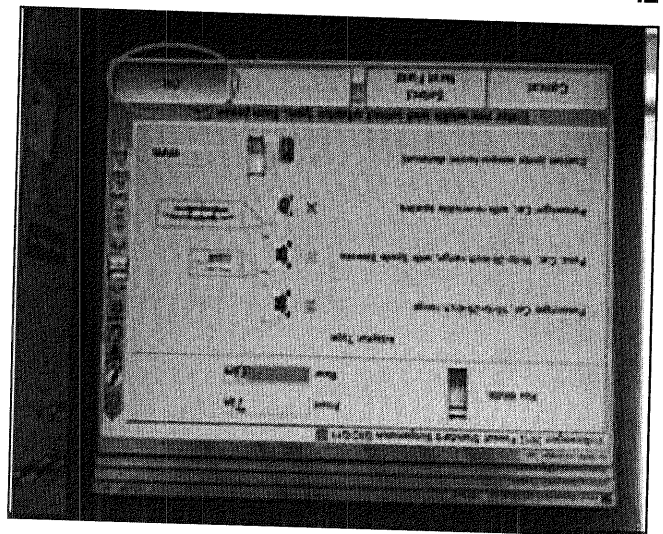

Figure 14

Steer the wheels straight ahead as instructed > Press K4 for Ready.

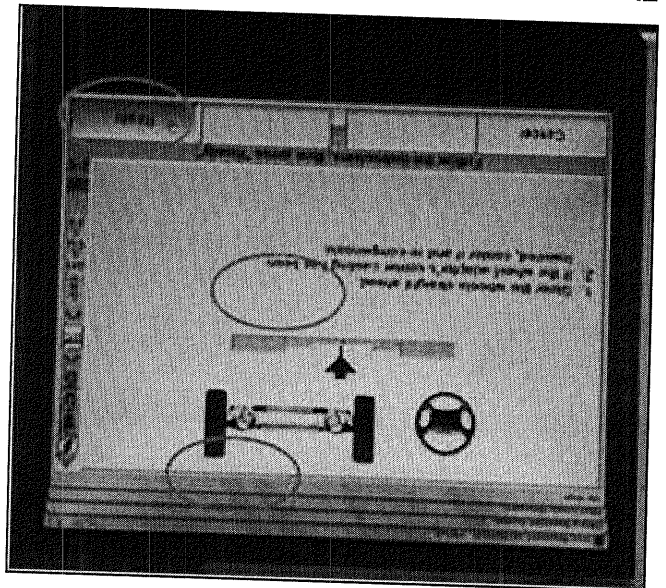

Figure 15

Track and wheelbase screen is displayed > Press K4 for OK.

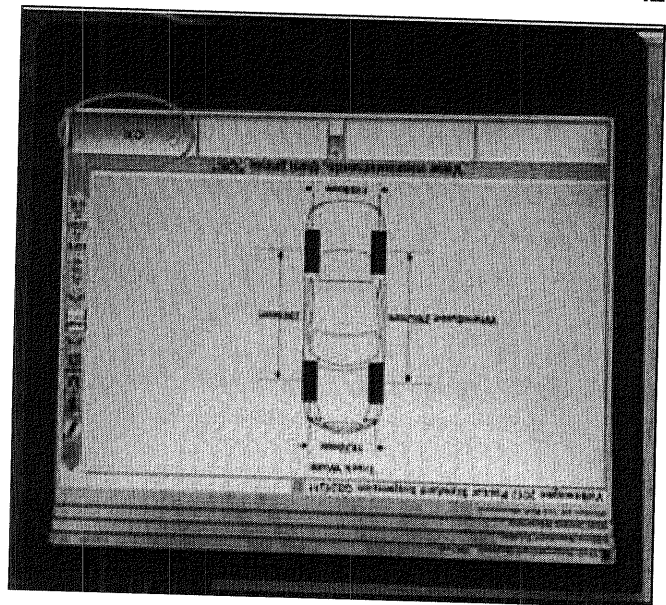

Figure 16

The axle symmetry measurement set back will now display in distances. Press K3 to print the alignment summary page.

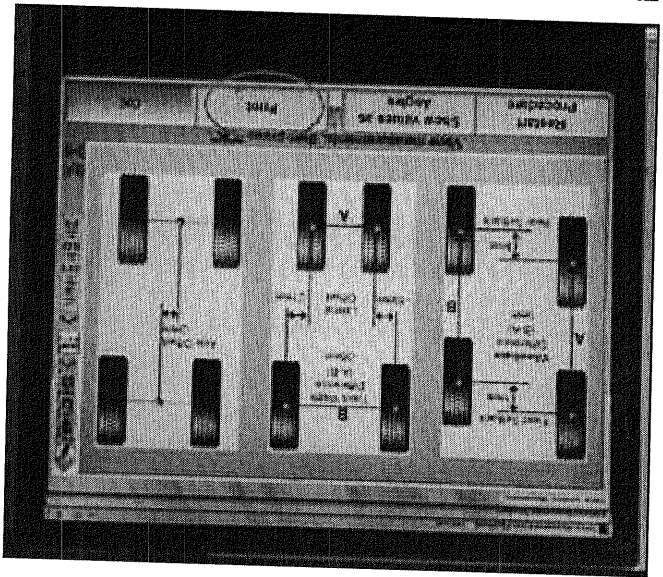

Figure 17

SECTION 2. Information on addressing drift/pull concerns at Pre-Delivery Inspection (PDI)

If it has been determined that a vehicle has a significant drift/pull on the PDI test drive, test drive a like vehicle on the same route to compare the drift. If the drift is similar, no further repair is necessary. If it has been determined that the drift is excessive compared to the like vehicle, perform an alignment check, and open a Volkswagen Technical Assistance (VTA) ticket, with the alignment measurements attached, and contact the Volkswagen Technical Helpline at 800-678-2389.

SECTION 3. Information on addressing customer concerns for vehicle drift/pull

1 Note:

Vehicle drift/pull diagnosis

Many factors related and non-related to a vehicle's suspension and/or tires can cause a vehicle to drift/pull. The tilt of the road surface (Road Crown) will have the most significant effect on the time it takes for a properly aligned vehicle to drift out of its lane. Always test drive the vehicle to determine that the vehicle drift is excessive before making any repairs or adjustments.

For customer concerns of vehicle drift/pull on vehicles that falls within the warrantable repair period, follow the step below to enhance the vehicle straight ahead tracking performance.

Step 1

Test drive the vehicle to determine the drift/pull.

Step 2

Perform an alignment check and make the necessary adjustments to bring the adjustable angles within specification.



Tip:

The net pull values of tires are affected by temperature of the tire when measurements are taken. To get the most accurate results performing StraightTrak® or Opti-line® immediately after the test drive.

As a vehicle suspension settles, some of the alignment angles may move out of specification. Under normal conditions the variation from the specified upper and lower limits of caster and camber should not exceed 30 minutes (0.5 degrees) and total toe should not exceed 5 minutes (0.08 degrees). If the variation is in excess of these values, the change in the suspension may be caused by an outside influence. For example, if the specification for total toe is 10 minutes +/-, the variation due to setting should not exceed +/- 20 minutes.



Note:

If the concern is due to an outside influence (e.g. accident) this bulletin doesn't apply.

Step 3

Selective tire placement to improve vehicle drift/pull

Use the Hunter GSP9700 Balance with StraightTrak or John Bean RFV200 with OptiLine to determine the best tire placement to improve vehicle drift/pull.



Note:

If the vehicle alignment is within specification, and you are unable to improve the vehicle drift using selective tire placement, open a VTA ticket and contact the Technical Helpline at 800-678-2389.

If the vehicle alignment is within specification, DO NOT attempt to optimize the alignment measurements, or improve vehicle drift, by shifting the vehicle sub frame. Shifting the vehicle sub frame will have no significant effect on the vehicle drift/pull.

Section 4. Information on using Volkswagen approved diagnostic balancers to address vehicle drift/pull

Hunter GSP9700 with StraightTrak



Tip

For details of using StraightTrak® on the Hunter GSP9700 please reference the operation manual. A copy of the document is located in Service Net under Workshop Equipment > Instruction Books > Hunter GSP9700 Road Force Wheel Balancer Operating Instructions.

Enabling 3D Diagnostics – From the home screen press F3 and select 3D Diagnostics.

Tip:

Make sure balancer is setup in 3D Diagnostics mode and that Opti-line® is enabled.

The information below is a guide on how to use the Opti-line® feature on the John Beam RFV2000 balancer. Please refer to the operation manual for more information about the equipment.

John Beam RFV2000 with OptiLine

The highest net pull is not always the ideal placement for the tires. A high net pull could cause the vehicle to start pulling in the opposite direction. It is always best to select the tire placement that will place a tire with high Road Force Variation (RFV) to the rear of the vehicle. For example, in figure 18 the tire placement to achieve -7 lbs net pull to the left will put tire # 4 on the left front of the vehicle. This may cause the customer to complain of vibration.

Tip:

When the suggested tire placements are displayed (Figure 18), select the combination that will best suit the vehicle driving conditions and then test drive the vehicle to check vehicle drift/pull.

Figure 18

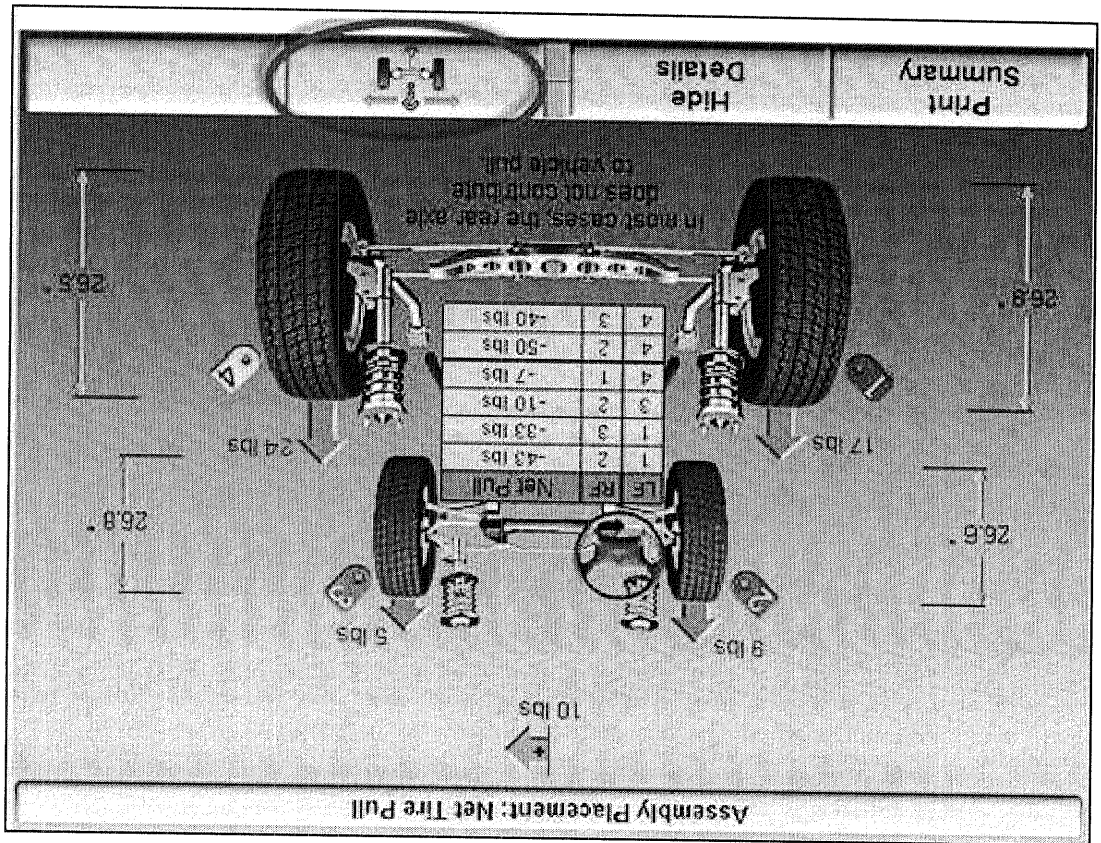

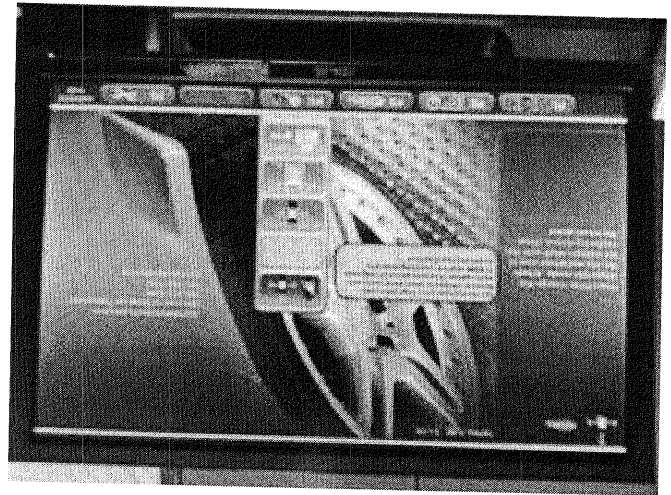

Figure 19

Enabling Opti-line® – From the home screen press F6 and select settings

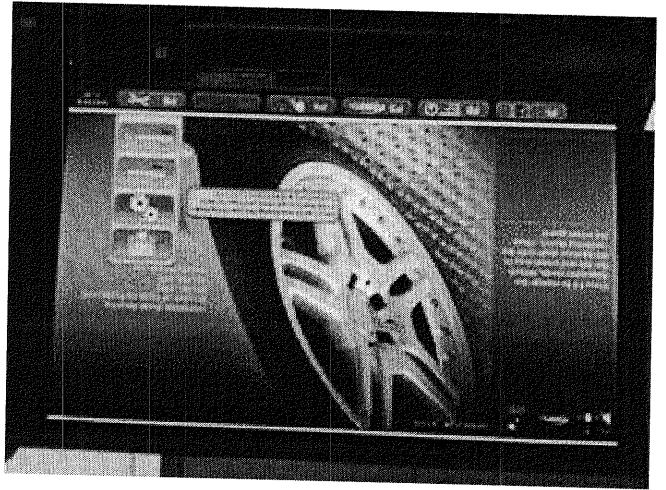

Figure 20

Select -> Optima Settings, -> tire pull measurement -> enable (Figure 19.3).
Return to the Home Screen and press F1 to go into the balance screen, then F3 to go into the optima screen. Press F5 to open the Opti-line® menu and select Enable Opti-line® (only option).

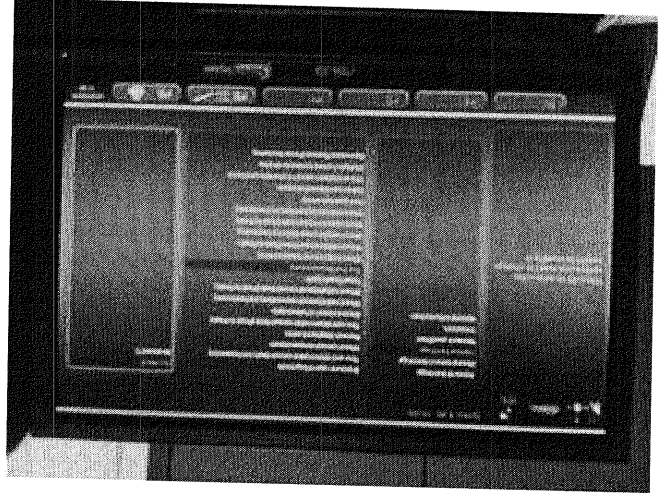
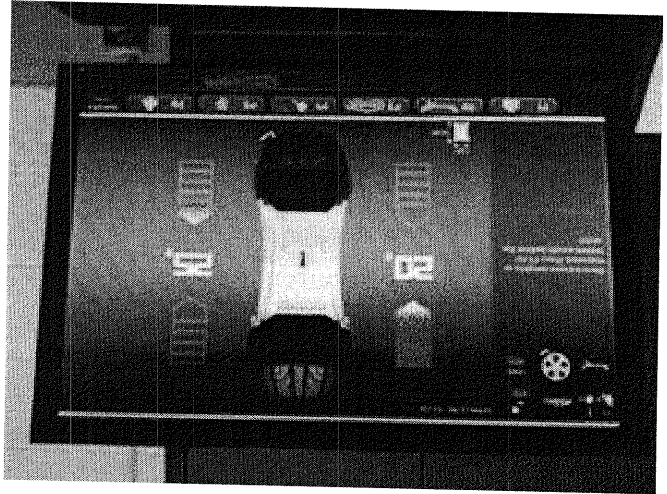

Figure 21

- Label wheels location on the car before removing. For example, LF (Left Front), RF (Right Front), etc.
- Mount the tire on the balancer using the flange plate with stud kit. Please note that in the Opti-line® function the balancer will number the wheels sequentially based on the order mounted.
- Balance each tire and add the tire to the wheel set.

Adding tires to wheel set



To open Opti-line® from the balance screen press F3 to open the Optima screen.

Figure 22

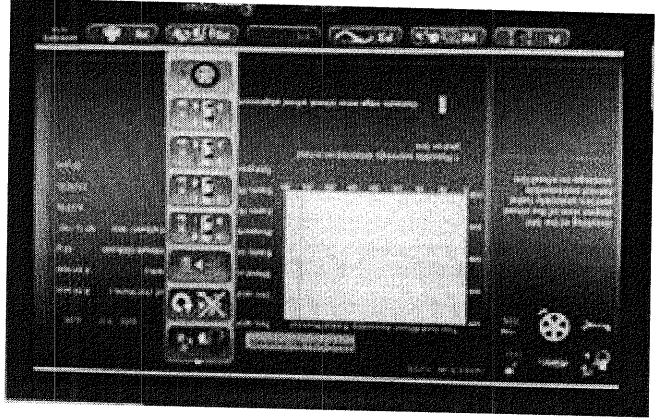

Press F5 to bring up the Opti-line® menu and select open Opti-line® screen.

Figure 23

First wheel balanced automatically selected as wheel # 1.

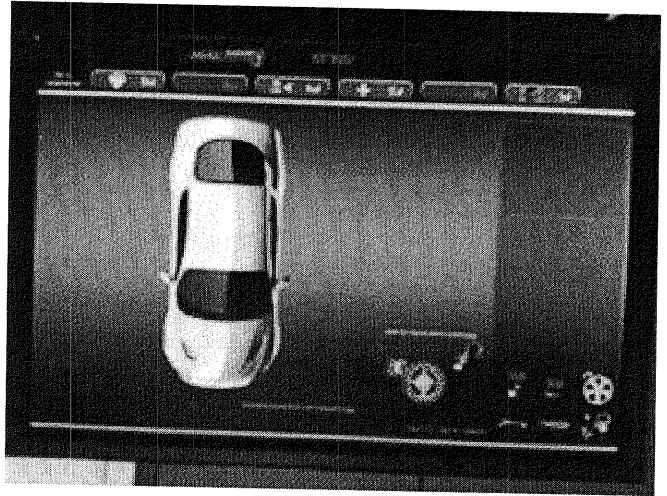

Figure 24

Press F3 to add the tire to the wheel set. Label the wheel # 1 (use chalk or accessory tags provided with the balancer) and repeat the process for the remaining wheels.

Tip:

Labeling the wheels is very important for further diagnosis. When the wheel set is completed each wheel should have two (2) labels. The wheel location on the car (LF, RF, LR & RR) and the wheel position in the wheel set (1,2,3,4)

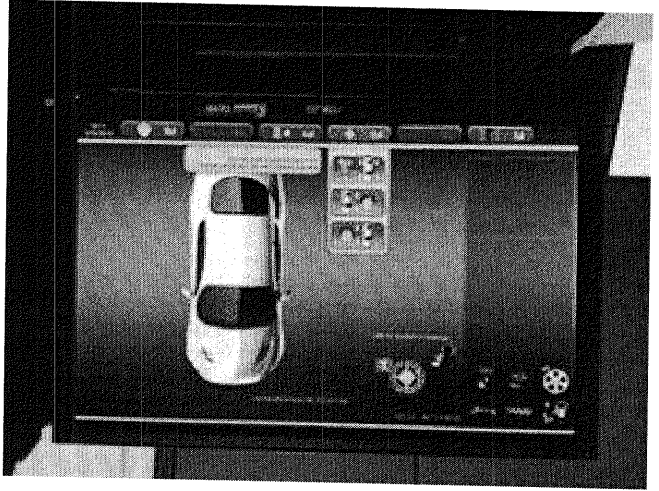

Figure 25

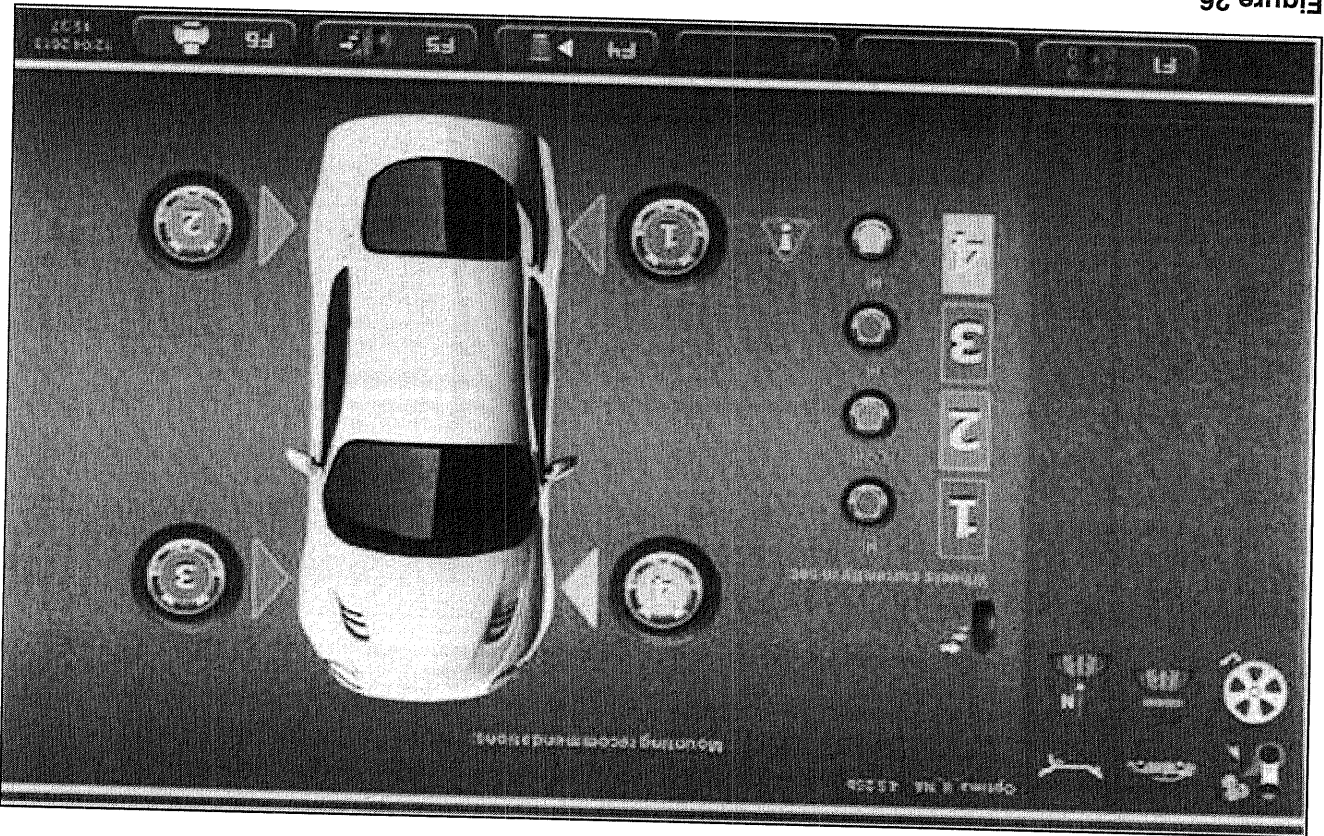

Figure 26

When all the wheels are entered in the wheel set, press F5 and select "Least Pull".

Tip:

Take a screen print or screen capture (picture) of the recommended wheel placement.

- Install the wheels in the suggested order and test drive the vehicle to check vehicle drift/pull.

Warranty

1 Note:

Please refer to the policy and procedure book for coverage.

PID 4485 should be used for all claims related to vehicle drifting / pulling or steering wheel off center. If alignment is required due to parts replacement, the claim should be filed under the PID for the causal part. DO NOT use PID 4485 to file claims for physical defects to steering components.

To determine if this procedure is covered under Warranty, always refer to the Warranty Policies and Procedures Manual 1)

Model(s)	Year(s)	Eng. Code(s)	Trans. Code(s)	VIN Range From	VIN Range
Passat, Jetta, Beetle Sedan	2012-2013	All	All	All	All

Jetta Hybrid, Beetle Convertible	2013	All	All	All	All
SAGA Coding					
Claim Type:					
Service Number:		4485	0011	--	Use applicable when indicate Eisaweb (L/R)
Damage Number:		Code	HST		Damage Location (Depends Service No.)
Claim Type:		110/910			
Parts Manufacturer		Passat	Jetta Sedan, Beetle		
		TX6 ²⁾	3ME ²⁾		
Labor Operation ³⁾ : Remove and Install 4 Wheels.		44052099 = 30 TU			
Labor Operation ³⁾ : Perform road force balance (Front & Rear axle).		44059499 = 70 TU			
Labor Operation ³⁾ : Modify Front & Rear Axle measurements.		44851699 = 90 TU			
Includes		<ul style="list-style-type: none"> • Modify Front Toe Adjustment (left and right side) • Modify Rear Toe Adjustment (left and right side) • Modify Front Camber Adjustment (left and right side) • Modify Rear Camber Adjustment (left and right side) 			
Causal Part:		Select labor operation 44851699			
Diagnostic Time ⁴⁾					
GFF Time expenditure		01500000 = 00 TU max.	NO		
Road Test		01210002 = 10 TU 01210004 = 10 TU	YES		
Technical Diagnosis		01320000 = 00 TU max.	NO		
Claim Comment: Input "As per Technical Bulletin 2031087" in comment section of Warranty Claim.					

1) Vehicle may be outside any Warranty in which case this Technical Bulletin is informational only

2) Code per warranty vendor code policy.

3) Labor Time Units (TUs) are subject to change with ELSA updates.

4) Documentation required per Warranty Policies and Procedures Manual.

Required Parts and Tools

No special parts required.

Tool Description	Tool No:
Alignment Equipment	VAS 6292 or Equivalent
Tire Balancer	VAS 6230A or Equivalent VAS 6311A or Equivalent

Additional Information

All part and service references provided in this Technical Bulletin are subject to change and/or removal. Always check with your Parts Dept. and Repair Manuals for the latest information.

© 2013 Volkswagen Group of America, Inc. All rights reserved. Information contained in this document is based on the latest information available at the time of printing and is subject to the copyright and other intellectual property rights of Volkswagen Group of America, Inc., its affiliated companies and its licensors. All rights are reserved to make changes at any time without notice. No part of this document may be reproduced, stored in a retrieval system, or transmitted in any form or by any means, electronic, mechanical, photocopying, recording, or otherwise, nor may these materials be modified or reposted to other sites, without the prior expressed written permission of the publisher.